

REMARKS: 1) *----- REFER TO COVER PAGE
 2) **----- X.XX=2.54 (FOR PIN LENGTH ≥ 3.2 & ≤ 10.00mm)
 ***----- X.XX=1.75 (FOR PIN LENGTH > 10.00 & ≤ 19.50mm)

VARITRONIX LTD.		Dimension : mm		TDL : ±0.15 IF NOT SPECIFY		3 rd ANGLE PROJECTION	
DWGNO. :	VIM-828-DP	REV	0	Drawn by :	FANG	SIGN :	
		Checked by :	MAKD	SIGN :		Date :	00-01-10
		Date :					

DWG.NO. : VIM-828-DP (REV.0)

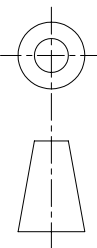
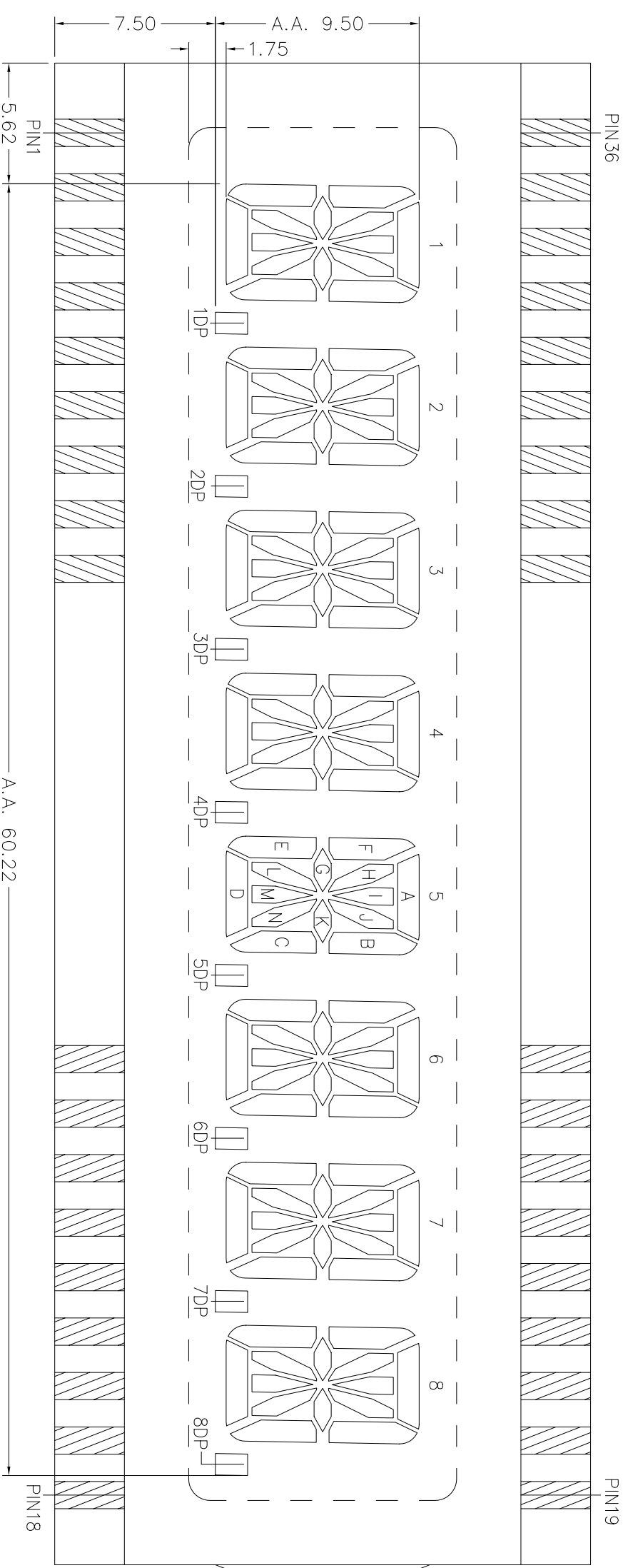

DWG. NO. : VIM-828-DP (REV.0)

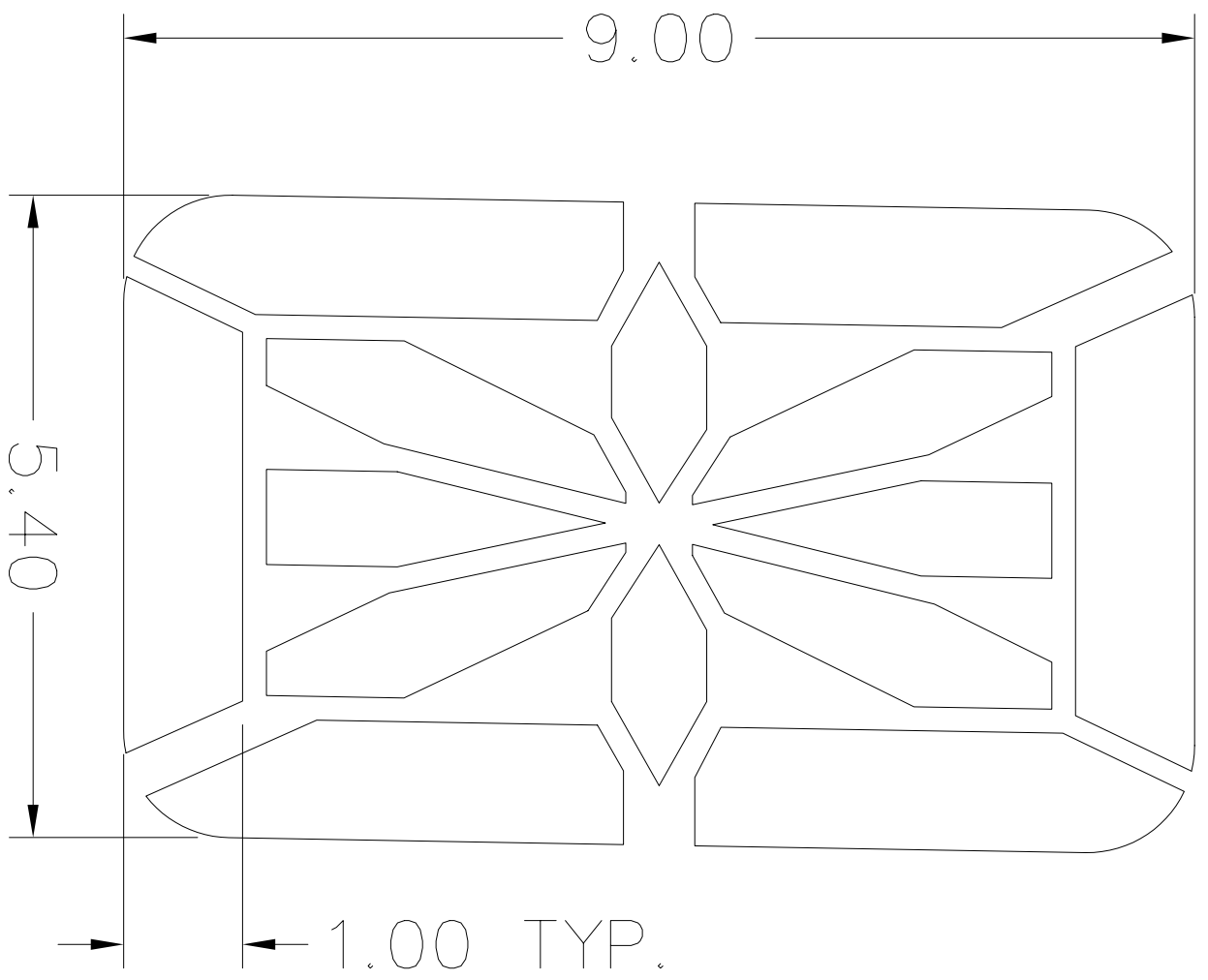

DIGIT 1 - 8

DWG.NO. : VIM-828-DP (REV.0)
SEGMENT TRACKING

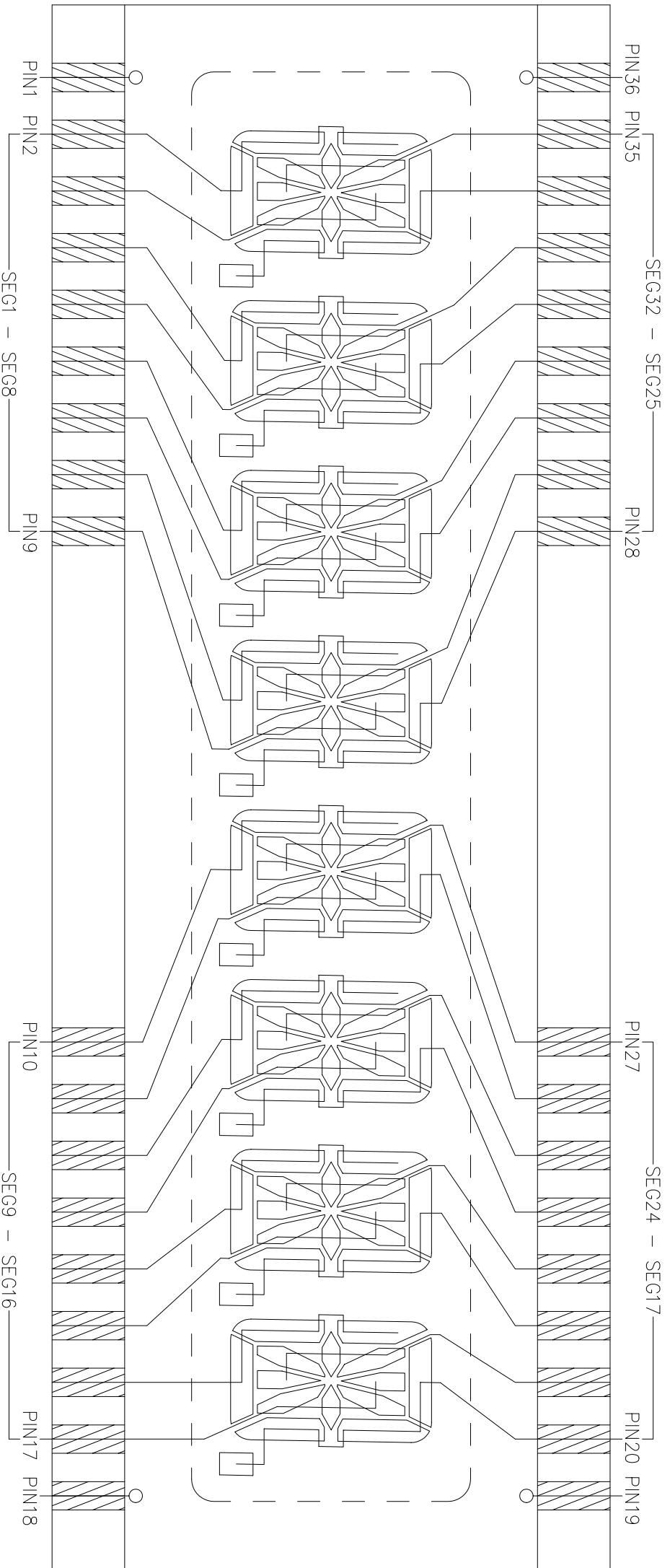

DWG.NO. : VIM-828-DP (REV.0)
COMMON TRACKING

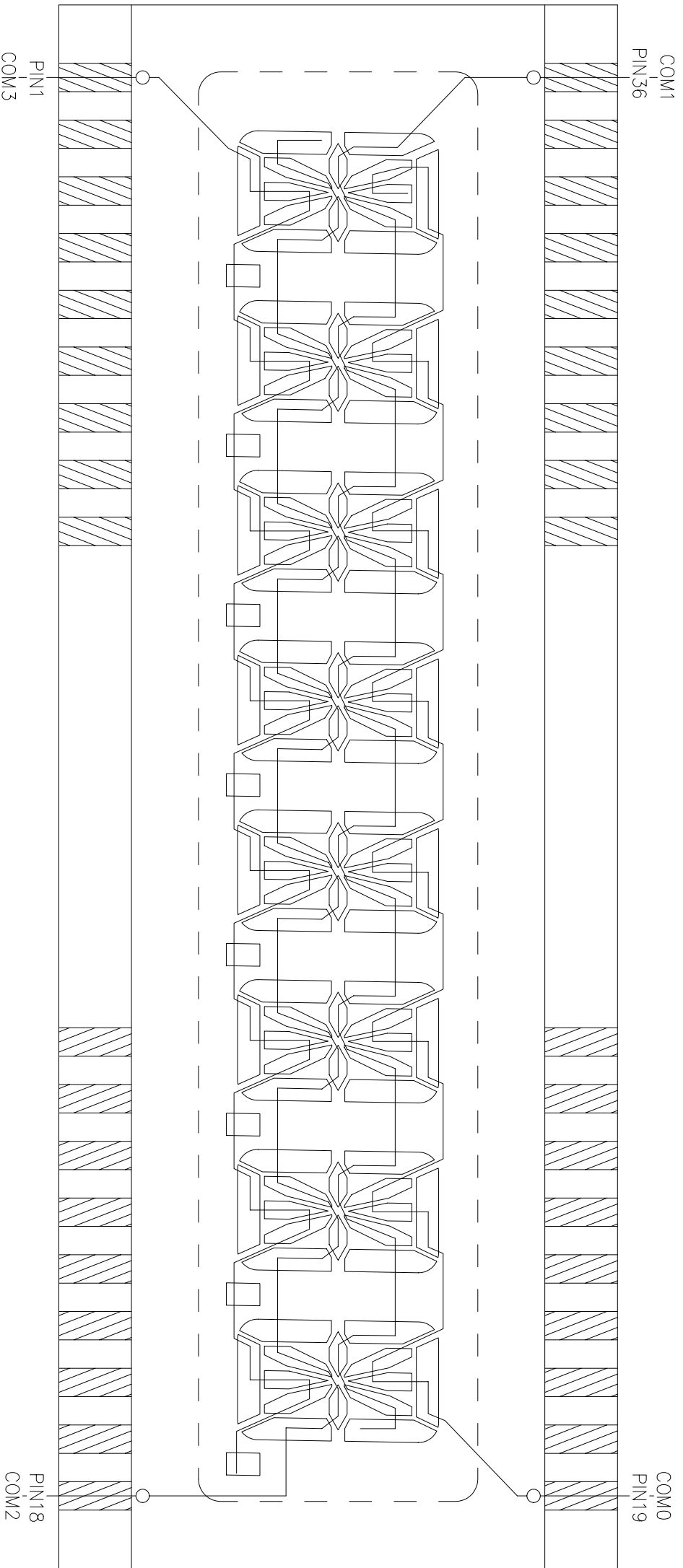

DWG.NO. : VIM-828-DP (REV.0)

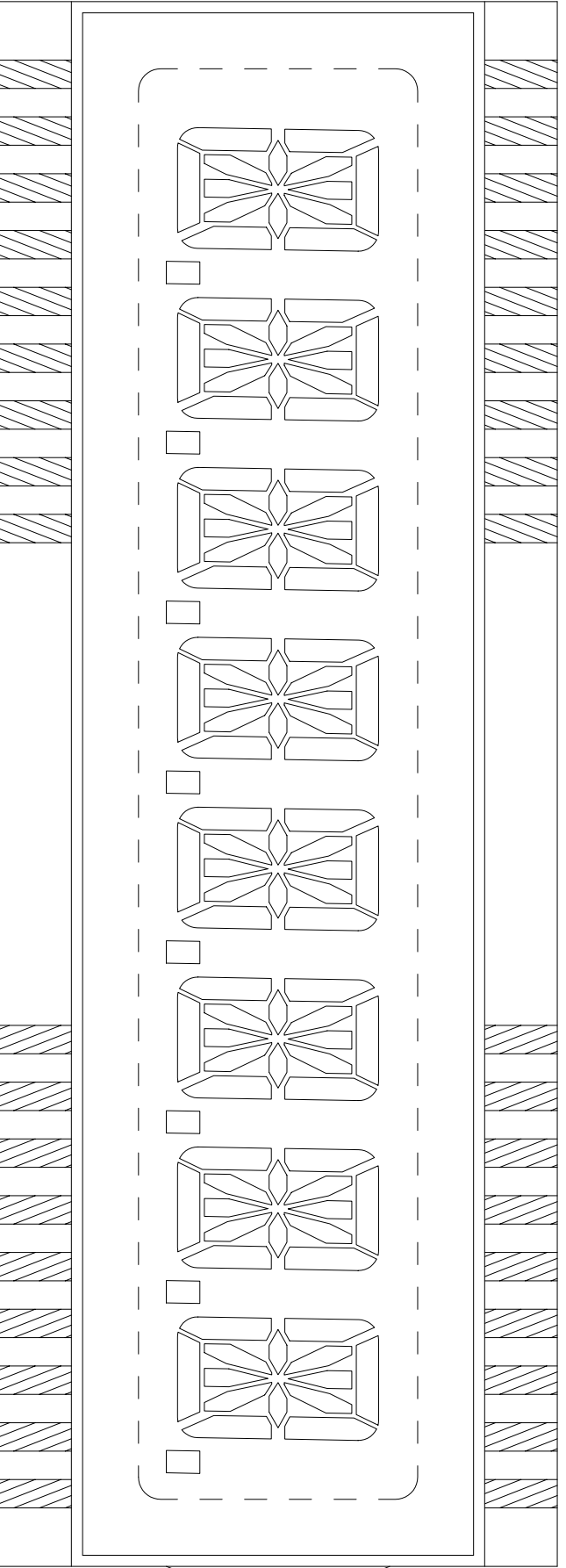

FRONT POLARIZER
FRONT GLASS
BACK GLASS
BACK POLARIZER

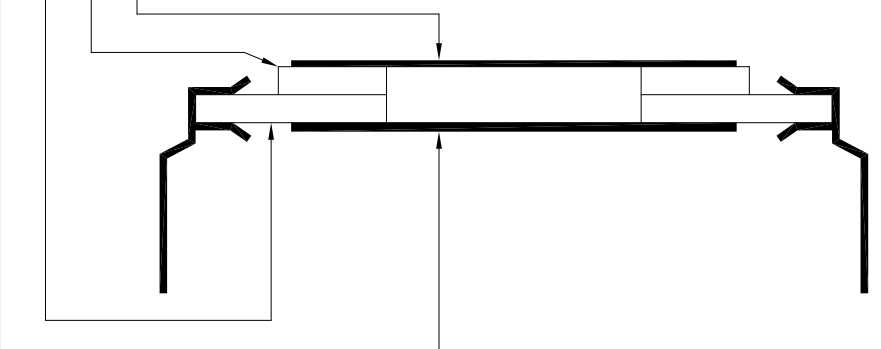

DWG.NO. : VIM-828-DP (REV.0)

PIN	COM0	COM1	COM2	COM3
1	----	----	----	COM3
2	----	1F	1E	1D
3	1I	1J	1K	1N
4	----	2F	2E	2D
5	2I	2J	2K	2N
6	----	3F	3E	3D
7	3I	3J	3K	3N
8	----	4F	4E	4D
9	4I	4J	4K	4N
10	----	5F	5E	5D
11	5I	5J	5K	5N
12	----	6F	6E	6D
13	6I	6J	6K	6N
14	----	7F	7E	7D
15	7I	7J	7K	7N
16	----	8F	8E	8D
17	8I	8J	8K	8N
18	----	----	COM2	----
19	COM0	----	----	----
20	8A	8B	8C	8DP
21	8H	8G	8L	8M
22	7A	7B	7C	7DP
23	7H	7G	7L	7M
24	6A	6B	6C	6DP
25	6H	6G	6L	6M
26	5A	5B	5C	5DP
27	5H	5G	5L	5M
28	4A	4B	4C	4DP
29	4H	4G	4L	4M
30	3A	3B	3C	3DP
31	3H	3G	3L	3M
32	2A	2B	2C	2DP
33	2H	2G	2L	2M
34	1A	1B	1C	1DP
35	1H	1G	1L	1M
36	----	COM1	----	----